

Description:

RX-TP5025-K10 medical plant growth module array lamp, Koray LED Grow Lights, Connected in series with 10pcs TP5025-80W , New patent design product with unique lens, Different LED chips in one lens, Concentrating Light efficiently and More uniform spectral radiation, directional light ,higher light utilization efficiency, more efficient comparing with common grow lights. Specially designed for medicinal planting, high PAR output, optimal plant-specific spectrum, to meet the light requirements of medicinal plants, fully stimulate medicinal ingredients. It is especially used for indoor planting of medicinal plants, planting planting tents, and scientifically experimenting planting. marijuana (cannabis)



1. Basement, grow tent planting medicinal plants
2. Large size 1.2x1.2m (5'x5'), multiple Bar arrays, uniform spectral radiation
3. High PAR output, PPFD>800μmol/m²/s, 1.2x1.2m Average value
4. Dedicated to medicinal and medical plant growth
5. Built-in power supply
6. Waterproof IP64, Can be used in humid environments
7. Input:AC100~277V, PF >0.9 Powr:640W
8. Long life up to 35,000 hours
9. CE RoHS FCC

Model	Dimension LxWxH	Spectral Wavelength	Photon PPFD μmol/m ² /s Total Power 640W	One Growth LED Bar Luminous flux PAR Output Power Input AC230V	Comment
RX-TP5025-K1060 D	1.2x1.2m (5 'x5 ')	V2	925μmol @0.3m 59719Lx	Flux 12063Lm PPF:180umol/s 80W PF >0.9	Light emission angle: 60° Ra88 2.3umol/J
			851μmol @0.5m 54613Lx		
			616μmol @1m 39071Lx		
RX-TP5025-K10-90 D	1.2x1.2m (5 'x5 ')	V2	938μmol @0.3m 58893Lx	Flux 12559Lm PPF:188umol/s 80W PF >0.9	Light emission angle: 90° Ra88 2.3umol/J
			847μmol @0.5m 53660Lx		
			421μmol @1m 26945Lx		

Surface temperature rise Tc 25° K , Operating temperature: -30° C ~ 40° C , Lifespan: 35,000 hours (Note: Ta ≤ 25° C)

Tolerance range for optical and electrical data: ±10 %. Recommended irradiation distance 0.15~ 1m;

PPFD test: Irradiation area 1.2x1.2m, divided into 36 areas, the average value of the test data . * D60 H 0.15m Uniformity is not good!

(Total PAR output: It is calculated by a single LED module) The above data is for reference only!

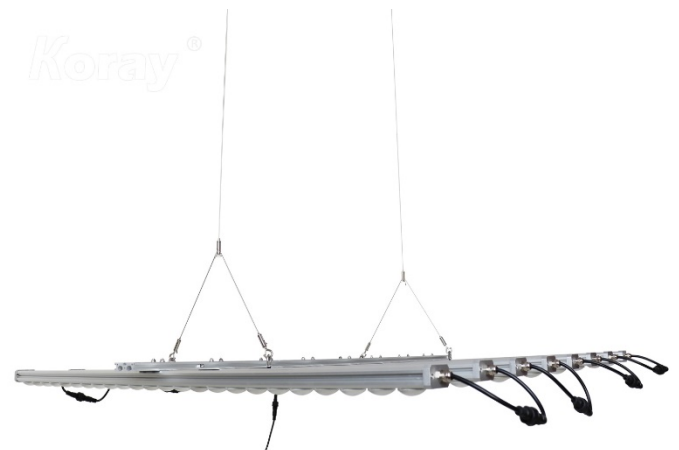
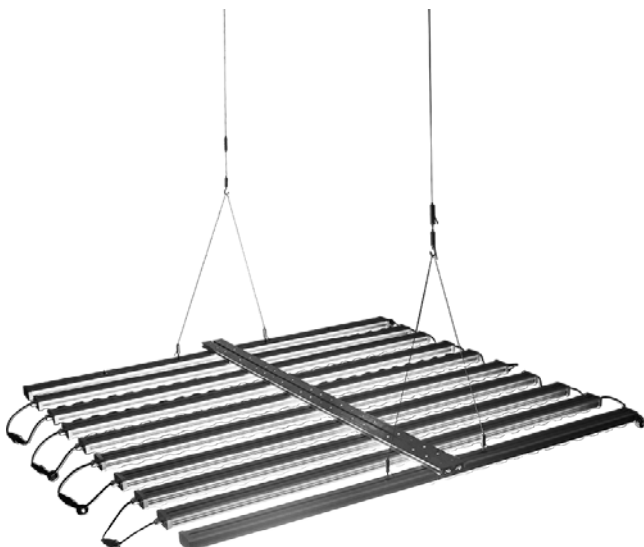

- Small size, high power 80W , built-in power supply

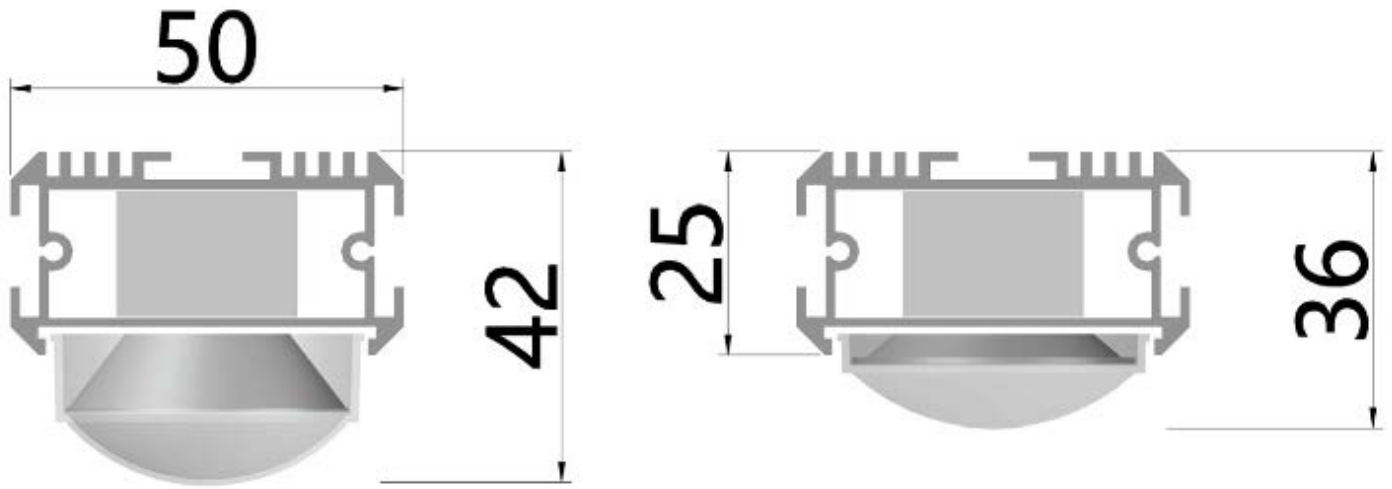

Small size, high power, built-in power supply

- Optional lens angle:



60D 60° lens reflector

60D



90D 90° lens reflector

90D

- RX-TP5025-K10-90D PPF Test

6" (0.15m) Test height (lighting distance between luminaire and plant canopy)

Average value of test points: 1192.3 μ mol/m²/s

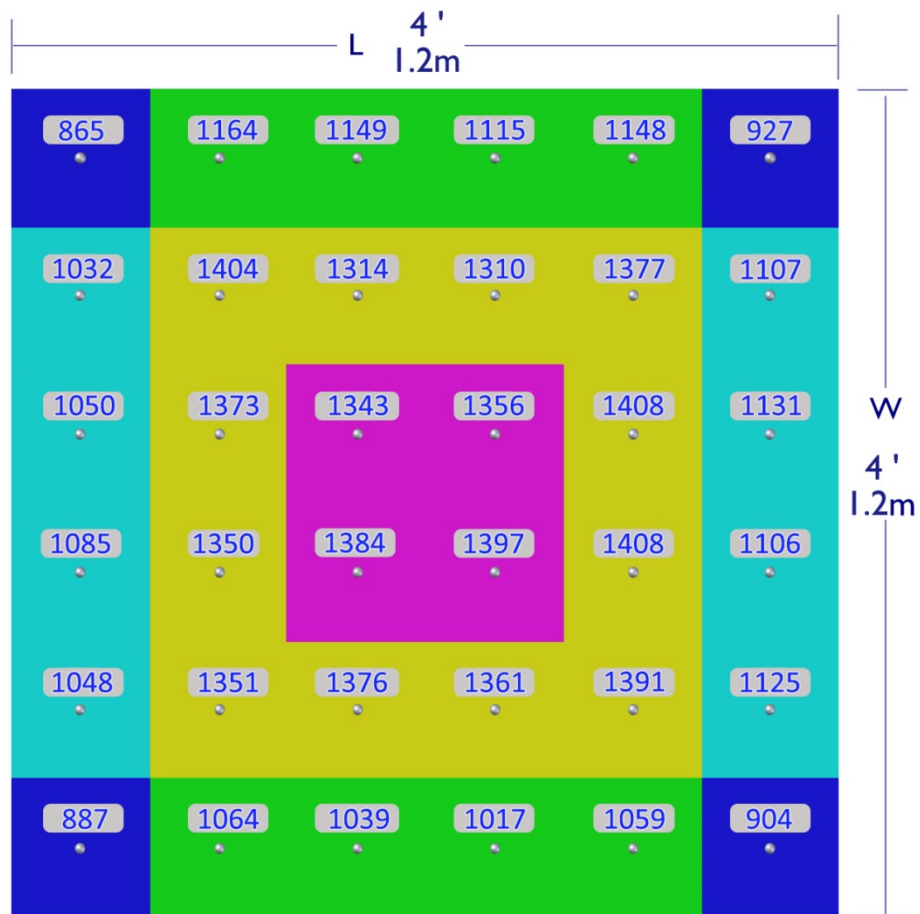
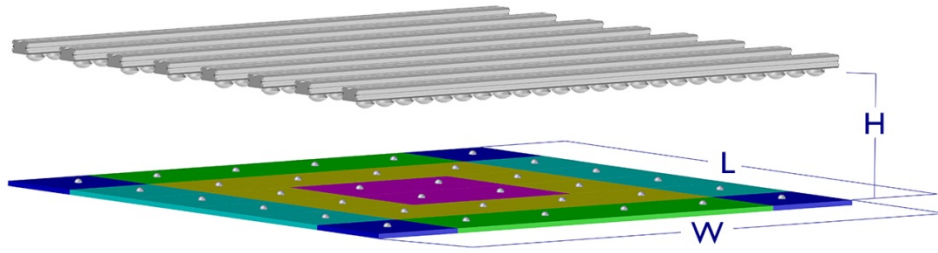

● PPF Test Point Average: 1192.3 μ mol/m²/s

RX-TP5025-K10-D90 800W Height 6" (0.15m) Test

● RX-TP5025-K10-90D PPFD Test

7.8" (0.2m) Test height (lighting distance between luminaire and plant canopy)

90D Average value of test points: 1096.3 $\mu\text{mol}/\text{m}^2/\text{s}$

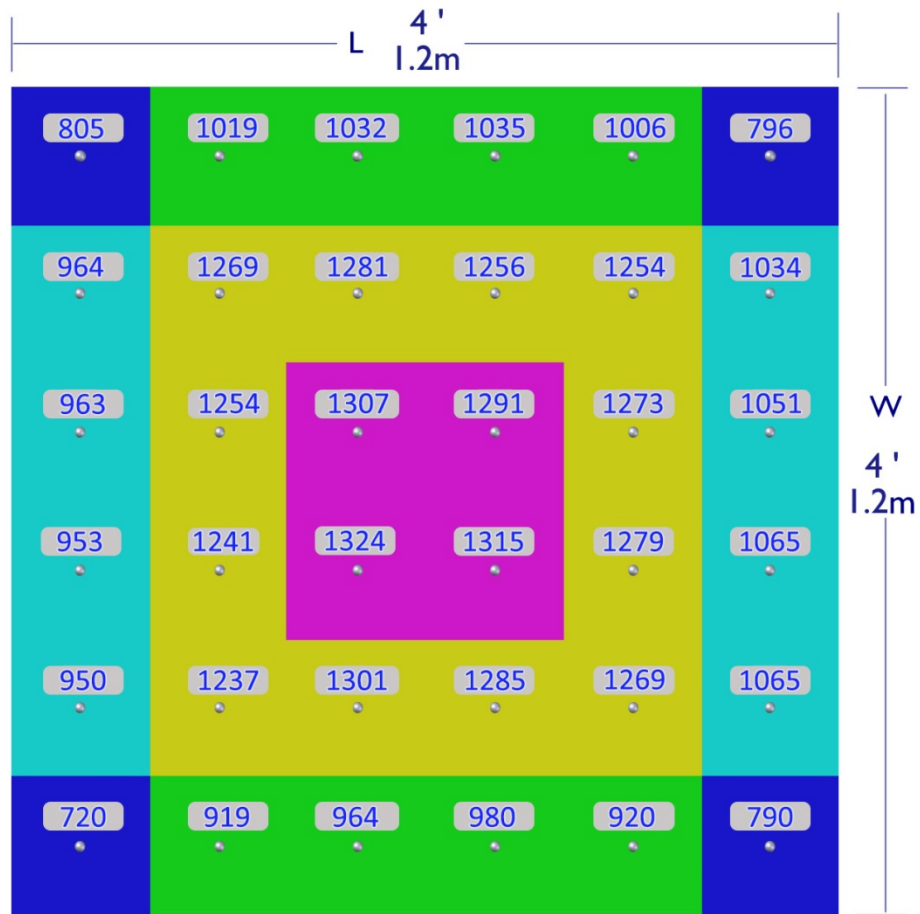
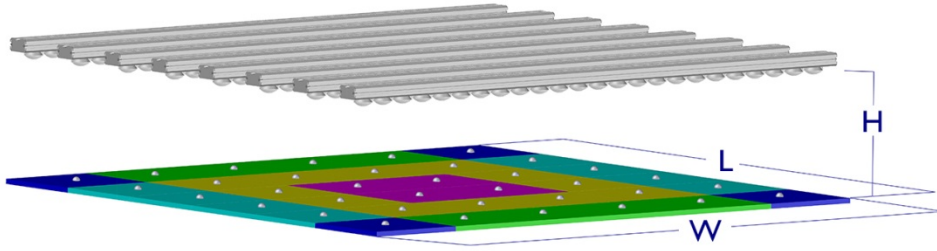

● PPFD Test Point Average: 1096.3 $\mu\text{mol}/\text{m}^2/\text{s}$

RX-TP5025-K10-D90 800W Height 7.8" (0.2m) Test

● RX-TP5025-K10-90D PPFD Test

11.8" (0.3m) Test height (lighting distance between luminaire and plant canopy)

Average value of test points: 757.7 $\mu\text{mol}/\text{m}^2/\text{s}$

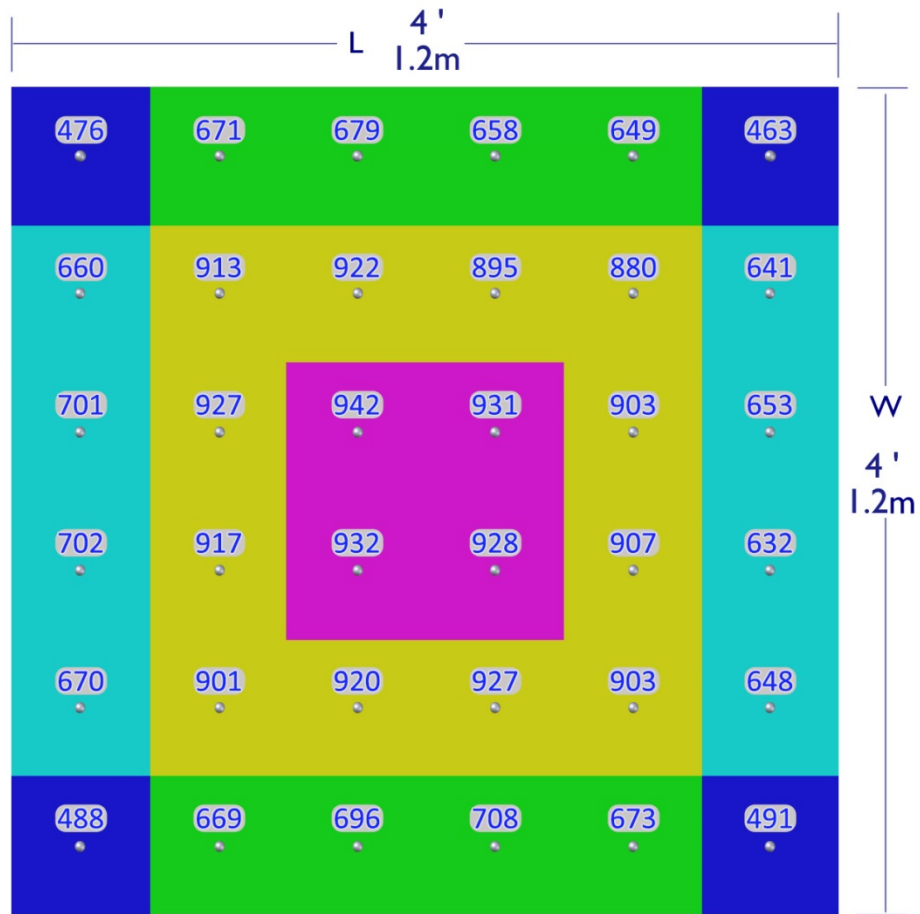
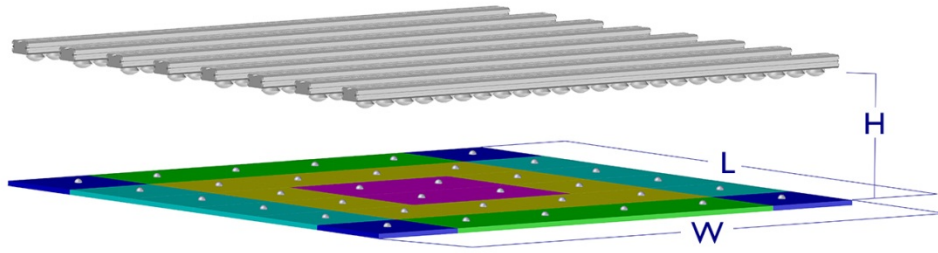

● PPFD Test Point Average: 757.7 $\mu\text{mol}/\text{m}^2/\text{s}$

RX-TP5025-K10-D90 800W Height 11.8" (0.3m) Test

- RX-TP5025-K10-90D PPF Test

19.7" (0.5m) Test height (lighting distance between luminaire and plant canopy)

Average value of test points: 749 μ mol/m²/s

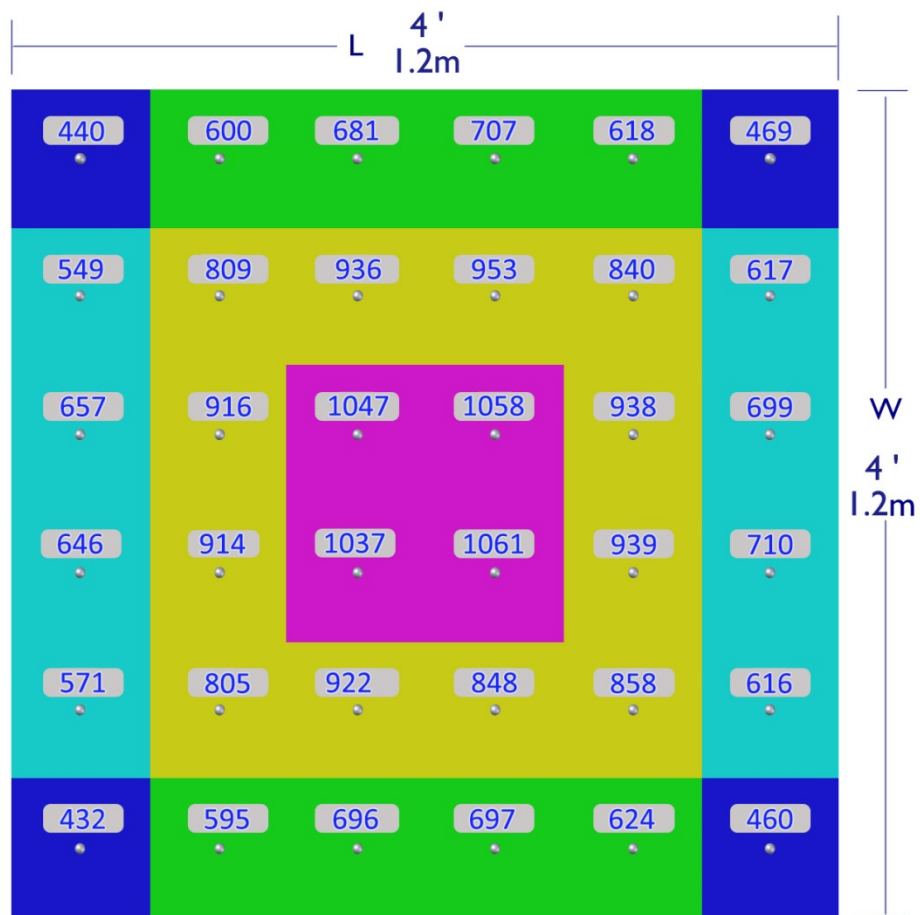
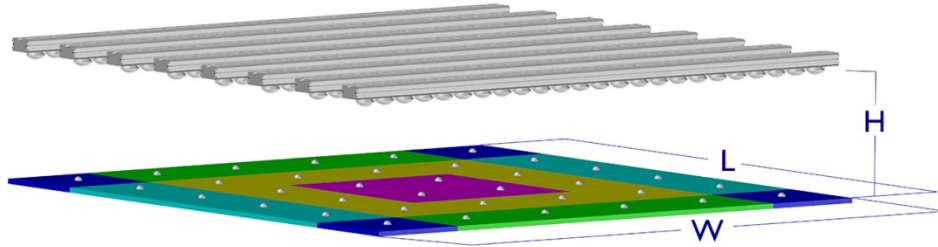

● PPF Test Point Average: 749 μ mol/m²/s

RX-TP5025-K10-D90 800W Height 19.7" (0.5m) Test

Note: The above data is for reference only!